

Female Header 2.54 mm

90° & 180° & SMT Series

SPECIFICATIONS

- Current Rating: 3 A
- Insulator Resistance: 5000 MOhm min.
- Contact Resistance: 20 mOhm max.
- Dielectric Withstanding: AC 1000 V
- Operating Temperature: -40°C ~ +105°C
- Soldering Temperature: 260°C for 3~5 sec. max
- Contact Material: Brass
- Insulator Material: Polyester, UL 94V-0
- Standard: P.B.T.
- Finish: Tin, Gold or Duplex Plated
- Standard: Gold Flash all over
- Note: Duplex Plating: Gold Plated on contact area, Tin on solder area

F201-RGP-D030-XX-WB

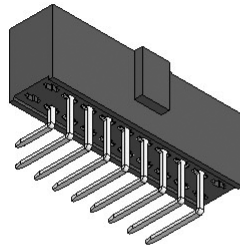

F201-MGN-D078-XX-WB

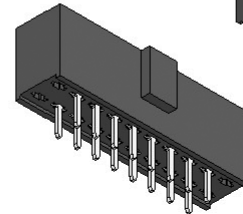
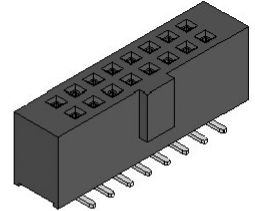

F201-SGP-D032-XX-WB

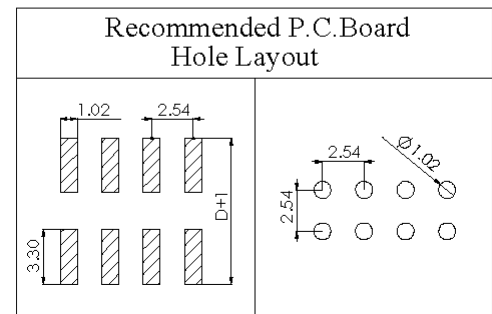
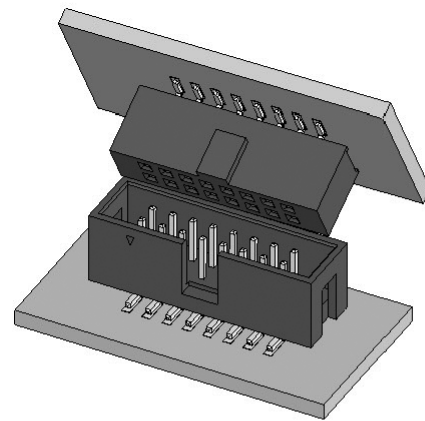
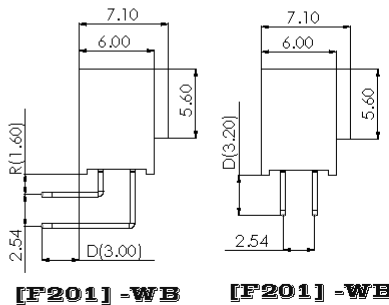
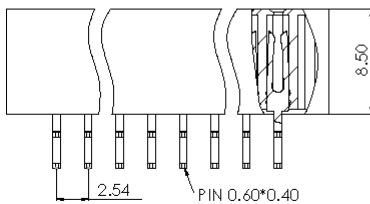
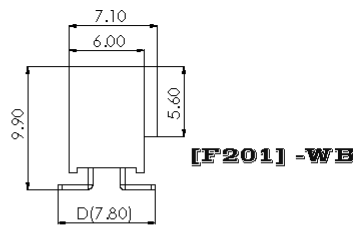
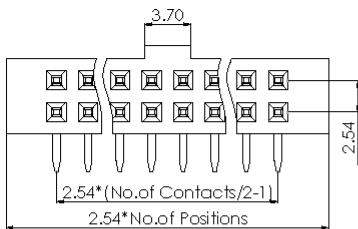

How to order

Unit: mm

Series	Connector Type	Contact Plating	Material	Pin Length mm	Number of Contacts	Other
FXXX	- X	X	X -	DXXX	- XX	- WB
F201:F/H 2.54 H:8.50 Dual Row	S: Straight Type M: SMT Type R: Right Angle R: 1.6 :	G: Gold Flash T: Tin Plated A: 10U"Gold B: 15U"Gold C: 20U"Gold © Duplex Plating D: Gold Flash/Tin (Standard: G)	P: PBT N: Nylon-6T (Standard: P)	S-D D032 M-D D078 R-D D030	(06 TO 80 Contacts)	WB: With polarization key block#1.#2. #N.#N -1PIN Move#1.#2. #N.#N -1PIN